



ITT

GSSINGLE

Residential Water Systems

1Ø Service Manual

- Submersible Pumps
- Jet Pumps



 **GOULDS PUMPS**

Goulds Pumps is a brand of ITT Corporation.

www.goulds.com

Engineered for life

Table of Contents

This manual covers single phase 4" submersible pumps and jet pumps.

	Page
Submersibles: (Pages 1 – 35)	
Typical Systems.....	1-3
Troubleshooting	4-9
Amprobe Instructions	10
Ohmmeter Instructions.....	11
A Capacitor Checkout.....	12-13
B Relay Checkout.....	14-16
C Overload Checkout.....	17
D Voltage Checkout	18-19
E Electrical Short Checkout.....	20-21
F Motor Winding Resistance Checkout.....	22-23
G Cable Checkout.....	24-25
H Amperage Checkout	26-27
I Pressure Switch Adjustment	28-29
J Pressure Tank Checkout.....	30-31
Submersible Pump Disassembly.....	32-33
Submersible Pump Reassembly.....	34-35
Jet Pumps: (Pages 36 – 71)	
Typical Systems.....	36-41
Troubleshooting	42-49
1 Voltage Checkout.....	50-51
2 Amperage Checks	52-53
Ohmmeter Checks	54-63
Wiring Diagrams.....	60-61
3 Checking Suction Lift	64-65
4 Pressure Control Valves	66-67
Jet Pump Disassembly.....	68-69
Jet Pump Reassembly.....	70-71

Typical Submersible System . . .

Three-wire system illustrated using galvanized tank.



RULE OF THUMB

1. Use same size or larger pipe as discharge on pump.
2. Always use a check valve for every 200 ft. of vertical pipe.

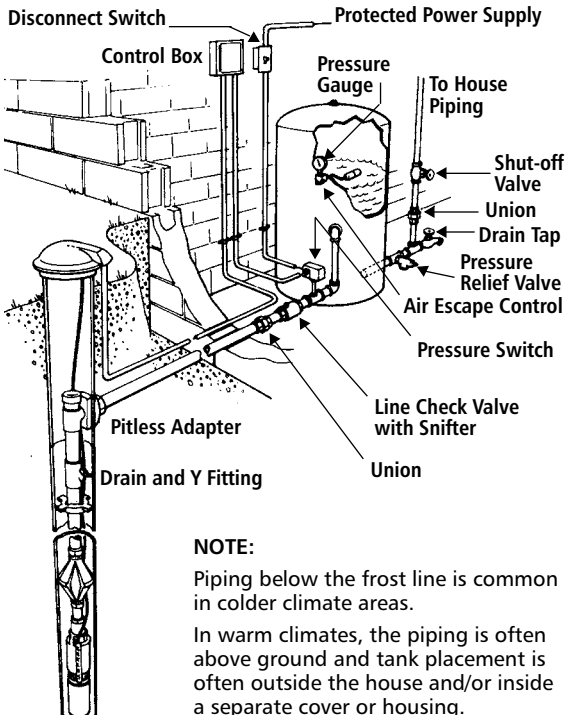

NOTE:

Piping below the frost line is common in colder climate areas.

In warm climates, the piping is often above ground and tank placement is often outside the house and/or inside a separate cover or housing.

Typical Submersible System . . .

Two-wire system illustrated; using diaphragm type tank.



RULE OF THUMB

1. Use same size or larger pipe as discharge on pump.
2. Always use a check valve for every 200 ft. of vertical pipe.

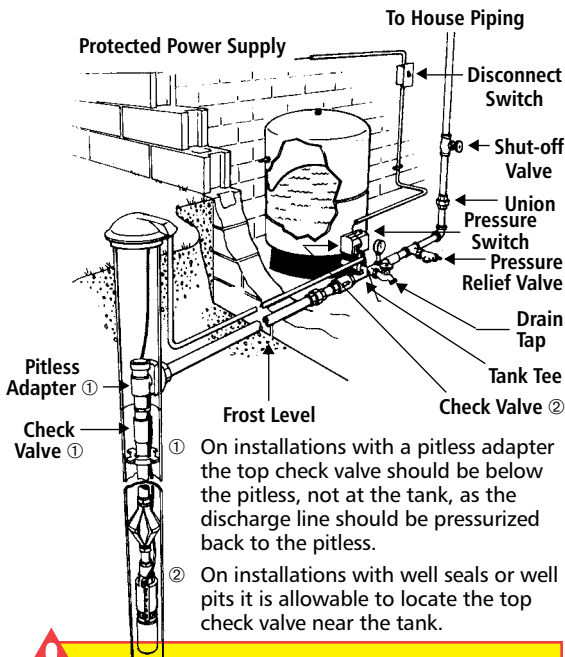

CAUTION

All electrical equipment must be connected to supply ground. Follow applicable code requirements.

Three-wire Single Phase Wiring Diagram:

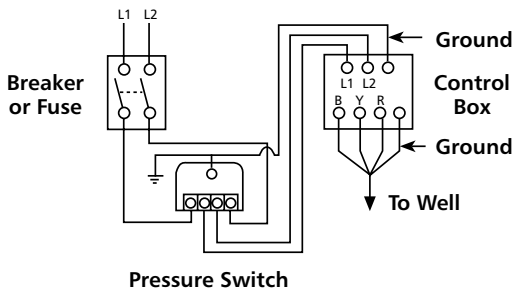

CAUTION

All electrical equipment must be connected to supply ground. Follow applicable code requirements.

Troubleshooting

INDEX

An amprobe and ohmmeter are essential for properly checking a system. Use of the amprobe is explained on page 10. Use of the ohmmeter is explained on page 11.

Find the basic problem . . . for which numerous symptoms are listed and possible solutions are given for each:

	Page
■ Pump Will Not Start.....	5
■ Pump Will Not Run	6
■ Pump Runs, But Little or No Water Delivered.....	7
■ Insufficient Tank Pressure.....	8
■ Pump Starts Too Frequently	9



RULE OF THUMB

Remember, there may be other system problems caused by auxiliary controls not covered in this booklet.



IMPORTANT

This manual is intended **ONLY** for use by professionals familiar with NEC (National Electric Codes) electrical codes and hydraulic and safety procedures of pump installations.

Letters and Numbers in chart, ex. "See A" refer to sections in the Manual. Submersible sections use letters and Jet sections are numbered.

Troubleshooting

Pump Will Not Start . . .

If fuses and overload check okay . . .

PROBLEM:

ANSWER:

1. No power or incorrect voltage	See D
2. Defective pressure switch	Inspect points and replace switch if necessary.
3. Loose connection in control box, cable or motor.	See E, F, G

Troubleshooting

Pump Will Not Run . . .

If motor overload trips or fuses blow . . .

PROBLEM:	ANSWER:
1. Improper size fuses	Replace with correct.
2. Wrong control box	Replace with correct.
3. Incorrect voltage	See D
4. Defective control box	See A, B, C
5. Loose connections in control box, cable or motor	See E Condition causes improper resistance readings.
6. Cable insulation damaged or splice may be open or shorted	See G Condition causes improper resistance readings.
7. Defective pressure switch or plugged tubing	Inspect points and/ or replace switch if necessary.
8. Control box in hot environment	Temperature not to exceed 122°F (50°C).
9. Pump bound by abrasives	Pull pump and clean. See H Condition causes high amperage.

Troubleshooting

Pump Runs, But . . .

Little or no water delivered . . .

PROBLEM:**ANSWER:**

1. Line check valve stuck or installed backwards	Replace if defective.
2. Connections loose or misconnected in control box	See wiring diagram in control box.
3. Incorrect voltage	See D
4. Pump not submerged	Check water level in well.
5. Leak in piping system	Replace if necessary.
6. Worn pump	Repair or replace water-end.
7. Worn motor	Replace motor.
8. Suction screen or impeller clogged	Pull pump and clean.
9. Broken pump shaft or coupling	Replace.

Troubleshooting

Insufficient Tank Pressure . . .

PROBLEM:**ANSWER:**

- | | |
|-------------------------------------|------------------------------------|
| 1. Improper pressure switch setting | See I |
| 2. Incorrect voltage | See D
Repair or replace. |
| 3. Excessive pump wear | Repair or replace. |
| 4. Leaks in piping system | Repair or replace. |

Troubleshooting

Pump Starts Too Frequently . . .

PROBLEM:	ANSWER:
1. Waterlogged tank a. Galvanized	Check tank for leaks. Check drain and "Y" fittings, snifter valve for proper operation.
b. Captive air type	See J
2. Check valve stuck open	Replace if necessary.
3. Improper pressure switch setting	See I
4. Leaks in piping system	Repair or replace
5. Pressure tank improperly sized	



RULE OF THUMB

Must be sized to allow a minimum run time per cycle as follows:

- $\frac{1}{3}$ – 1½ HP = 1 minute run time
- 2 HP & larger = 2 minute run time

Amprobe Instructions



The Amprobe is a multi-range, combination ammeter and voltmeter.

Voltmeter Scales:	150 VOLTS	600 VOLTS
Ammeter Scales:	5 AMPS	40 AMPS
	15 AMPS	100 AMPS

1. When used as an ammeter, the tongs are placed around the wire being measured with the rotary scale on the **100 amp range**. Then rotate the scale back to the smaller ranges until an exact reading is indicated.
2. When used as a voltmeter, the two leads are clipped into the bottom of the instrument with the rotary scale on the 600 volt range. If the reading is less than 150 volts, rotate the scale to the 150 volt range to get a more exact reading.

Ohmmeter Instructions



The Ohmmeter is used for measuring the electrical resistance of a wire circuit. The unit of measurement is called an Ohm.

1. The knob at the bottom of the Ohmmeter is adjustable through six ranges:

RX_1	=	$R \times 1$
RX_{10}	=	$R \times 10$
RX_{100}	=	$R \times 100$
RX_{1000}	=	$R \times 1,000$
RX_{10K}	=	$R \times 10,000$
RX_{100K}	=	$R \times 100,000$

If your ohmmeter is digital readout type, refer to the instructions that came with it.

2. The round center knob is for the purpose of adjusting the instrument to zero (0) after clipping the two ohmmeter leads together. **This must be done every time the range selection is changed.**



CAUTION

Use Ohmmeter only with **power off**.

A Capacitor Checkout

Capacitor with Ohmmeter



CAUTION

Discharge the capacitor before making this check. (A screwdriver can be used to make contact between capacitor's posts.)

1. Disconnect leads to capacitor post.
2. Setting: R x 1,000
3. Connect ohmmeter leads to capacitor posts.
4. Reading: Pointer should swing toward zero, then back toward infinity.

A Capacitor Checkout

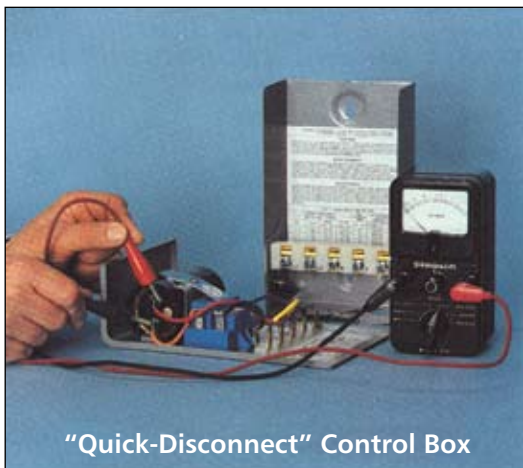

RULE OF THUMB

To recheck, reverse the
OHMMETER LEADS.

B Relay Checkout *Voltage Relay Control Boxes (CentriPro or F.E.)*

Checking Relay with Ohmmeter

A. Voltage Relay

$\frac{1}{2}$ – 1 HP CP - QD; 1 – 15 HP CSCR Control Boxes

Step 1, Coil Test

1. Meter setting: R x 1,000.
2. Connections: #2 & #5.
3. Correct meter readings:

For 115 Volt Boxes:

.7 – 1.8 (700 to 1,800 ohms).

For 230 Volt Boxes

4.5 – 7.0 (4,500 to 7,000 ohms).

Step 2, Contact Test

1. Meter setting: R x 1.
2. Connections: #1 & #2.
3. Correct meter reading:
Zero for all models.



B. F.E. Blue Relay - Solid State
 $\frac{1}{3}$ – 1 HP QD Control Boxes

Used from 1994 until present time:

Step 1, Triac Test

1. Meter setting:
R x 1,000.
2. Connections: Cap
and B terminal.
3. Correct meter
reading: *Infinity*
for all models.

Step 2, Coil Test

1. Meter setting:
R x 1.
2. Connections:
L1 and B.
3. Correct meter
reading: *Zero*
ohms for all models.

C. F.E. Black Solid State Switch
 $\frac{1}{3}$ – 1 HP QD Control Boxes

Used from 1985 until 1994

Step 1, Triac Test

1. Meter setting:
R x 1,000.
2. Connections:
R (Start) terminal
and orange lead
on start switch.
3. Correct meter
reading: *Infinity*
for all models.

Step 2, Coil Test

1. Meter setting:
R x 1.
2. Connections:
Y (Common)
and L2.
3. Correct meter
reading: *Zero*
ohms for all
models.

B Relay Checkout *Continued*

Contactor Checkout

Checkout procedure for magnetic and other Contactors

Contactor Coil Test

(Disconnect lead from one side of coil)

1. Meter setting: R X 100
2. Connections: Coil terminals
3. Correct meter reading: 180 to 1,400 ohms

Contactor Contact Test

1. Meter Setting: R X 1
2. Connections: L1 & T1 or L2 & T2
3. Manually close contacts
4. Correct meter reading: Zero ohms

Additional information on troubleshooting and replacement parts for Single Phase Control Boxes is available in the ITT, MAID; Motor Application, Installation Manual and in the F.E. AIM. It is available online at www.goulds.com and www.franklin-electric.com.

C Overload Checkout . . .

For 1½ HP (and Larger) Control Box . . .

1. Set Ohmmeter at "R x 1"
2. Connect the Ohmmeter leads to Terminal #1 and #3 on each Overload Protector.
3. Reading should be not more than 0.5 Ohms maximum on the scale.

CSCR or Mag. Contactor Control Box

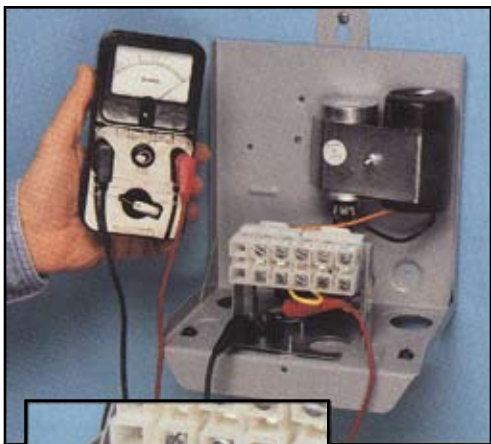

D Voltage Checkout

To Check Voltage with "Q.D." Type Control Box

1. Remove cover to break all motor connections.



CAUTION

L_1 and L_2 are still connected to power.

2. To check VOLTAGE: Use voltmeter on L1 and L2 as shown.
3. When checking voltage, all other major electrical appliances (that could be in use at the same time) should be running.
4. If readings are not within the limits (see chart), call your power supplier.

Voltage Limits		
Nameplate ▼	Measured Volts	
	Min.	Max.
115V 1Ø	105	125
208V 1Ø	188	228
230V 1Ø	210	250

D Voltage Checkout

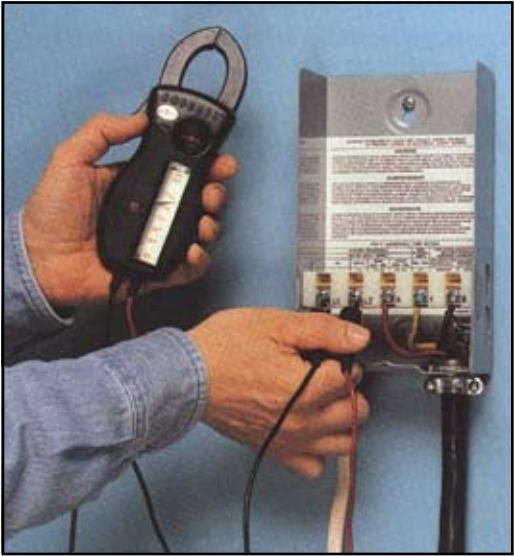

E Electrical Short Checkout . . .

Measuring Insulation Resistance

1. Set the scale lever to R x 100K and adjust to 0.



CAUTION

Open (turn off) master breaker and disconnect all leads from control box or pressure switch (Q-D type control, remove lid) to avoid damage to meter or electric shock hazard.

2. Connect an ohmmeter lead to any one of the motor leads and the other to the metal drop pipe. If the drop pipe is plastic, connect the ohmmeter lead to the metal well casing or ground wire.

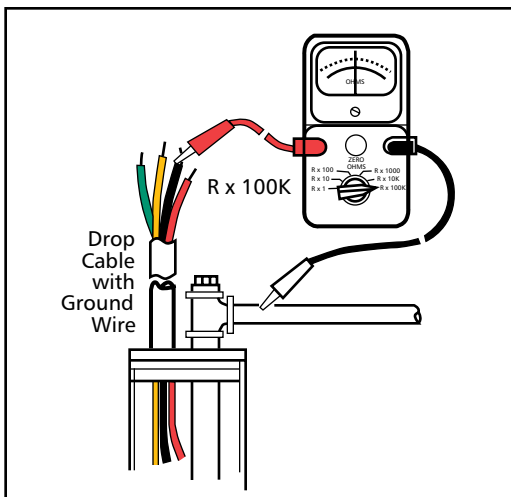

Table 1 Normal Ohm and Megohm Values (Insulation Resistance) Between All Leads and Ground

Insulation resistance does not vary with rating. All motors of all HP, voltage and phase rating have similar values of insulation resistance.

Condition of Motor and Leads	Ohm Value	Megohm Value
A new motor (without drop cable).	20,000,000 (or more)	20.0
A used motor which can be reinstalled in the well.	10,000,000 (or more)	10.0
Motor in Well. Ohm readings are for drop cable plus motor. A new motor in the well.	2,000,000 (or more)	2.0
A motor in the well in reasonably good condition.	500,000 – 2,000,000	0.5 – 2.0
A motor which may have been damaged by lightning or with damaged leads. Do not pull the pump for this reason.	20,000 – 500,000	0.02 – 0.5
A motor which definitely has been damaged or with damaged cable. The pump should be pulled and repairs made to the cable or the motor replaced. The motor will not fail for this reason alone, but it will probably not operate for long.	10,000 – 20,000	0.01 – 0.02
A motor which has failed or with completely destroyed cable insulation. The pump must be pulled and the cable repaired or the motor replaced.	Less than 10,000	0 – 0.01

What It Means

1. If the ohm value is normal, the motor windings are not grounded and the cable insulation is not damaged.
2. If the ohm value is below normal, either the windings are grounded or the cable insulation is damaged. Check the cable at the well seal as the insulation is sometimes damaged by being pinched.

Winding Resistance Measuring

When measured as shown on page 22, motor resistance only should fall within the values in Table 3, page 23. When measured through the drop cable, the size and length of the cable must be known and the correct cable resistance from Table 2 subtracted from the ohmmeter reading to get the winding resistance for comparison with Table 3.

F Motor Winding Resistance Checkout . . .

Measuring Winding Resistance

1. Set the scale lever to R x 1 for values under 10 ohms. For values over 10 ohms, set the scale lever to R x 10. Zero balance the ohmmeter as described earlier on page 11.



CAUTION

Open master breaker and disconnect all leads from control box to pressure switch (Q-D type control, remove lid) to avoid damage to meter or electric shock hazard.

2. Connect the ohmmeter leads as shown below.

Table 2 Cable Resistance – Copper

Size Cable	DC Resistance of Cable per 100 Foot Length Ohms per Pair of Leads
14	.544
12	.338
10	.214
8	.135
6	.082
4	.052
2	.032

If aluminum cable is used the readings will be higher. Divide the ohm readings on this chart by 0.61 to determine the actual resistance of aluminum cable.

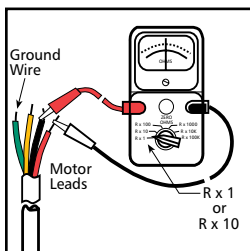

Table 3 Motor Resistance

Single Phase Motors – Winding Resistance Motor Only (Ohms)

4" Motors			CentriPro		Franklin Electric	
Type	HP	Volts	Winding Resistance	KVA Code	Winding Resistance	KVA Code
2-Wire (PSC)	1/2	115	1.3-1.8	K	1.0-1.3	R
	1/2	230	4.5-5.2	K	4.2-5.2	R
	3/4	230	3.0-4.8	J	3.0-3.6	N
	1	230	4.2-5.2	F	2.2-2.7	N
	1 1/2	230	1.9-2.3	H	1.5-1.9	M

4" Motors			CentriPro			Franklin Electric		
Type	HP	Volts	Resistance		KVA Code	Resistance		KVA Code
			Main (B-Y)	Start (R-Y)		Main (B-Y)	Start (R-Y)	
3-Wire w/Q.D. Cap. Start	1/2	115	.9-1.6	5.7-7.0	N	1.0-1.3	4.1-5.1	M
	1/2		4.2-4.9	17.4-18.7	M	4.2-5.2	16.7-20.5	M
	3/4		2.6-3.6	11.8-13	L	3.0-3.6	10.7-13.1	M
	1		2.2-3.2	11.3-12.3	L	2.2-2.7	9.9-12.1	L
3-Wire w/CSCR (CR) Control Box	1 1/2	230	1.6-2.3	7.9-8.7	J	1.7-2.2	8.0-9.7	J
	2		1.6-2.2	10.8-12.0	G	1.8-2.3	5.8-7.2	G
	3		1.1-1.4	2.0-2.5	G	1.0-1.5	3.5-4.4	H
	5		.62-.76	1.36-1.66	E	.68-1.0	1.8-2.2	F

6" Motors			CentriPro				Franklin Electric		
Type	HP	Volts	Resistance			KVA Code	Resistance		KVA Code
			R - Y	B - Y	R - B		(B-Y)	(R-Y)	
6" Single Phase	5	230	2.172	0.512	2.627	G	.55-.68	1.3-1.7	E
	7.5		1.401	0.4	1.774	F	.36-.50	.88-1.1	F
	10		1.052	0.316	1.31	E	.27-.33	.80-.99	E
	15		0.678	0.23	0.85	D	.17-.22	.68-.93	E



RULE OF THUMB

Add resistance of drop cable when checking pump in well. See Table 2 page 22.

What it Means

1. If all ohm values are normal, the motor windings are neither shorted nor open, and the cable colors are correct.
2. If any one ohm value is less than normal, the motor is shorted.
3. If any one ohm value is greater than normal, the winding or the cable is open or there is a poor cable joint or connection.
4. If some ohm values are greater than normal and some less, the leads are mixed.

G Cable Checkout . . .

Checking Cable and Splice

1. Submerge cable and splice in steel barrel of water with both ends out of water.
2. Set ohmmeter selector on RX100K and adjust needle to zero (0) by clipping ohmmeter leads together.
3. After adjusting ohmmeter, clip one ohmmeter lead to barrel and the other to each cable lead individually, as shown.
4. If the needle deflects to zero (0) on any of the cable leads, pull the splice up out of the water. If the needle falls back to (∞) (no reading) the leak is in the splice.
5. If leak is not in the splice, pull the cable out of the water slowly until needle falls back to (∞) (no reading). When the needle falls back, the leak is at that point.
6. If the cable or splice is bad, it should be repaired or replaced.

Checking Cable and Splice Test

Ohmmeter
Set at R x 100K

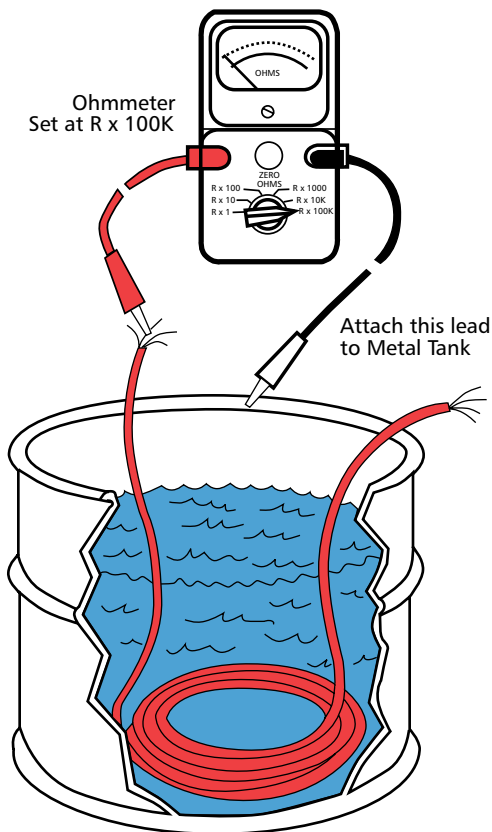

H Amperage Checkout . . .

Service Factor Amps w/QD (1/2 - 1 HP) or
CSCR (1.5 HP & larger) Control Boxes

4" 1Ø		CP 3-Wire			F.E. 3-Wire			CP 2-Wire	F.E. 2-Wire
HP	Volts	Yel	Black	Red	Yel	Black	Red	Black	Black
1/2	115	12.6	12.6	0	12.0	12.0	0	9.5	12.0
1/2	230	6.3	6.3	0	6.0	6.0	0	4.7	6.0
3/4		8.3	8.3	0	8.0	8.0	0	6.4	8.0
1		9.7	9.7	0	9.8	9.8	0	9.1	9.8
1 1/2		11.1	11.0	1.3	11.5	11.0	1.3	11.0	13.1
2		12.2	11.7	2.6	13.2	11.9	2.6	N/A	
3		16.5	13.9	5.6	17.0	12.6	6.0		
5		27.0	22.0	10.0	27.5	19.1	10.8		

Service Factor Amps w/Magnetic Contactor
Control Boxes

6" Single Phase		CentriPro 3-Wire			Franklin Elec 3-Wire		
HP	Volts	Yel	Black	Red	Yel	Black	Red
5	230	27.5	N/A	N/A	27.5	17.4	10.5
7.5		41.0	N/A	N/A	42.1	40.5	5.4
10		58.0	N/A	N/A	51.0	47.5	8.9
15		85.0	N/A	N/A	75.0	62.5	16.9

Control Box With Cover Attached

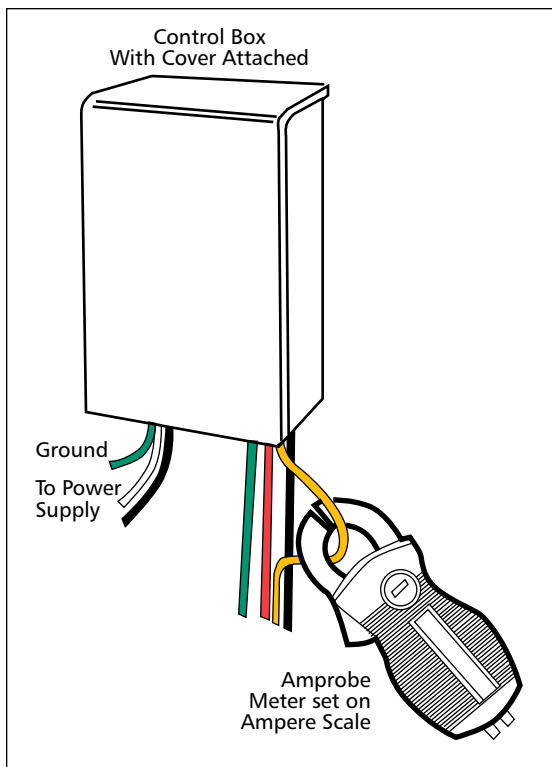

I Pressure Switch Adjustment Checkout . . .

CentriPro and Square D

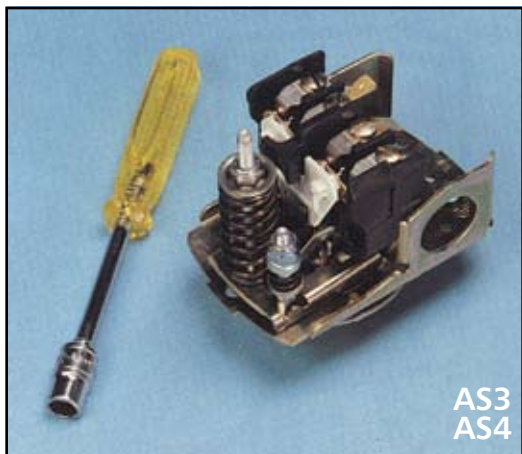

Adjust in Proper Sequence:

1. **CUT-IN:** Turn range nut (big Spring) down for higher cut-in pressure, or up for lower cut-in.
2. **CUT-OUT:** Turn differential nut (small spring) down for high cut-out pressure, or up for lower cut-out.



CAUTION

To avoid damage, do not exceed maximum allowable system pressure. Check switch operation after resetting. Max. Square D pressure 65 PSI, Max. CentriPro pressure 80 PSI.

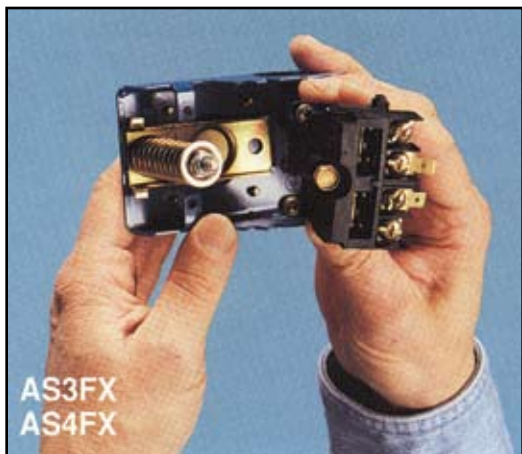
FURNAS

- 1. MAIN SPRING ADJUSTMENT:** Turn clockwise to increase both Cut-Out and Cut-In pressure. (2 PSI/turn).
- 2. DIFFERENTIAL ADJUSTMENT:** Turn differential nut clockwise to increase Cut-Out pressure without affecting Cut-In (3 PSI/turn).

**CAUTION****(FURNAS)**

To avoid damage, do not exceed maximum allowable system pressure. Check switch operation after resetting. Maximum pressure 80 PSI.

J Pressure Tank Checkout Procedure . . .

1. To check: Shut off power supply and drain system to "0" pressure.
2. Air pre-charge in tank should be 2 psi less than the cut-in pressure of the pressure switch.

Example: If pressure switch setting is 30-50 psi, tank should be pre-charged with 28 lbs. air.

3. If water at valve, replace tank.



RULE OF THUMB

Improper tank sizing may cause motor damage.

½ to 1½ HP pumps – Tank draw down should be equal to the pump capacity in GPM or greater.

Example: ¾ HP pump; capacity 12 GPM; pressure switch setting 30/50 PSI; correct tank – V140.

2 HP and larger pumps – tank drawdown should be **double** the pump capacity in GPM.

Example: 3 HP pump; capacity 30 GPM; pressure switch setting 40/60 PSI; correct tank selection: 2 – V350 tanks.



Shown with base extension

Repair or Replace – Some Considerations –
While our pumps are designed for ease of repair it is important to compare the cost of repair versus the cost of water end replacement. Replacing typical wear parts such as impellers and diffusers is a cost effective choice. However, if the outside metal parts such as the casing, motor adapter and discharge head all require replacement due to extremely harsh water it may be less expensive to simply purchase a complete new water end. A new casing or discharge head will require drilling and tapping for two new cable guard holes.

Pump Disassembly for Typical 4" Submersible Pumps...

1. Remove 4 cable guard screws and remove cable guard.
2. Reinstall top 2 screws so that discharge head and casing may be removed as one piece.



3. Using two pipe wrenches or a vice and pipe wrench, hold the motor adapter and turn the discharge head/casing assembly clockwise (it has left-hand threads) to loosen the assembly.

4. Remove the casing assembly to expose the stages.
5. Remove the klip ring from the top of the shaft, this will allow you to remove the stages from the shaft. Note that on units which have operated in sandy water it may be hard to disassemble the stages.
6. The complete stages should be removed one at a time, disassembled and inspected. Replace worn parts as needed.
7. On most models the shaft and coupling assembly is replaceable without removing the motor adapter. Lift the shaft off and inspect the coupling and motor splines for excessive wear.
8. If motor replacement is necessary, remove the 4 nuts from the motor studs and separate the motor and motor adapter. If motor is OK, leave assembly intact.
9. The shaft sleeve is now part of the shaft/coupling assembly and will not have to be ordered as a replacement part. Shaft couplings are not available alone as they are a pressed part. Replace the entire shaft/coupling assembly if either shows wear.
10. We use several check valve styles. Some are built-in and some screw in from the top (outside) of the discharge head. Replace as necessary. Replacement of a "GS" check valve will require separation of the discharge head and casing as it installs from inside the discharge head. You may also replace it using a standard screw-in line type check valve.

Pump Reassembly . . .

1. Clean all parts including the strainer. Replace basket type internal strainer now.
2. Place shaft and coupling assembly (and spacer where used) onto motor spline.
3. Reattach the motor adapter to the motor. Tighten the nuts in an alternating pattern.
4. Place straight edge across the rim of motor adapter. If it fails to touch the shaft sleeve, add one or more .010" shims (repair part No. 7K155) until they are either flush with motor adapter or slightly high, never low.
5. Install first stage bowl, first stage impeller, and diffuser.
6. Stack-up of the impeller hubs is checked by straight edge. Install succeeding stages in the same manner as the first. Check stack-up at least every second or third stage. If straight edge laid across the diffuser face fails to contact the impeller hub, a shim should be added (underneath the impeller). This will keep the bottom of the impeller from dragging on the bowl. Longer units have one intermediate bearing spider and sleeve, which should be placed to divide the stages evenly.



7. When all stages are in place, replace klip ring on shaft.
8. Check upper bearing for wear and replace if loose on shaft. Replace bearing spider on stack.
9. Replace casing/discharge head assembly, turning counterclockwise (left-hand threads). Turn it all the way down so that the casing bottoms against the flange on the motor adapter.
10. Using a pipe wrench on the motor adapter and one on the discharge head, tighten to approximately 85 lbs/ft. This will be approximately $\frac{1}{8}$ to $\frac{1}{4}$ turn from the hand tight position.
11. Remove the upper cable guard screws and replace the cable guard using all 4 screws. The cable guard should be straight up and down if the casing is properly tightened.
12. If you installed a new casing or discharge head they will have to be drilled and tapped to provide holes for the cable guard screws. Use a $\frac{9}{64}$ " drill and an 8-32 NC tap.
13. Replace the external wrap around strainer where used. New part number is 7K2242.

Jet Pumps . . .

Since these are the basic types that have been used for many years, the vast majority of jet pump service work will be on these types . . .

Horizontal Jet



J+

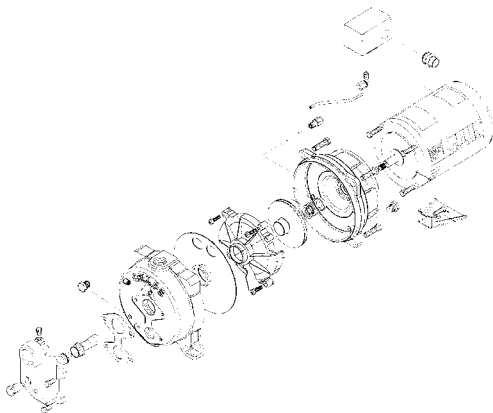

Vertical Jet



SJ

Typical Jet Pump System . . .

Shallow Well

System illustrated is a Convertible jet pump with a shallow well adapter and a pressure tank.



RULES OF THUMB

- All jet pumps should be located at the highest point in the suction side of the system.
- (Distance from well head to pump) If offset is greater than 20' . . . increase horizontal pipes by one size each.
- Never use pipes smaller than the pump suction tapplings.

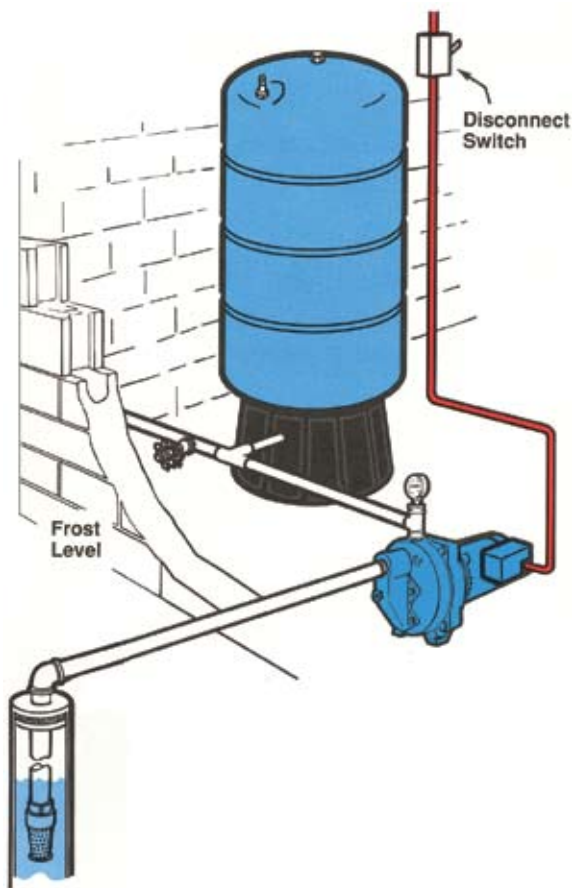

Typical Jet Pump System . . .

Deep Well

Packer and twin pipe systems

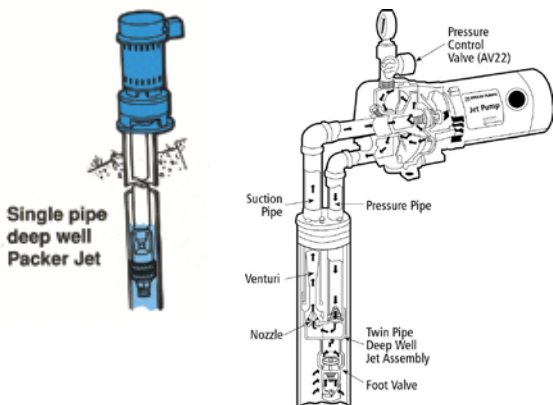

Improper Installations

- Trap air
- Hard to prime

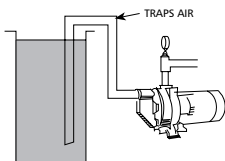

Proper Installations

- Easy to prime

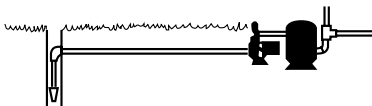
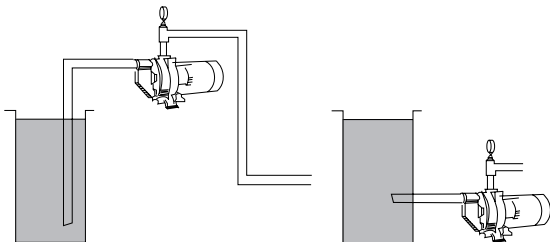

Troubleshooting

INDEX

An amprobe, ohmmeter and vacuum pressure gauge are essential for properly checking a system. Use of the amprobe is explained on page 10. Use of the ohmmeter is explained on page 11. Use of the compound vacuum pressure gauge is explained on page 66.

Find the basic problem . . . for which numerous symptoms are listed and possible solutions are given for each:

	Page
■ Pump Will Not Run	43
■ Pump Runs, But Little or No Water Delivered	44-45
■ Pump Starts and Stops Too Often	46-47
■ Insufficient Tank Pressure	48
■ Switch Does Not Cut Out	49



RULE OF THUMB

Remember there may be other system problems caused by auxiliary controls not covered in this booklet.

Troubleshooting

Pump Will Not Run . . .

PROBLEM:	ANSWER:
1. Blown fuse or power turned off	Replace fuse – close all switches.
2. Broken or loose wiring connections.	Examine all wiring and repair any bad connections.
3. Motor overload protection contacts open.	Overload contacts will close automatically in a short time.
a. Improper voltage.	See 1 Volt Ammeter
b. Pump bound mechanically – will not turn freely.	Remove motor end cap, turn motor shaft by hand. Unit should rotate freely.
4. Pressure switch faulty or out of adjustment.	Adjust or replace switch. See I.
5. Tubing or fittings on pressure switch plugged.	Remove switch tubing and/or all fittings and clean.
6. Faulty motor.	See 2

Troubleshooting

Pump Runs But . . .

Little or no water delivered . . .

PROBLEM:	ANSWER:
1. Pump or pipes not completely primed.	Fill pump completely with water through priming opening (reprime pump). a. Deep Well system Control valve must be set properly or system will not pump. See 4
2. Foot valve or end of suction pipe either not submerged or buried.	a. Shallow Well system Install vacuum gauge See 3 b. Deep Well system Physically check well conditions.
Foot valve in well or line check valve stuck closed.	Replace foot valve if necessary. (Very high vacuum, 22 inches or more, see 3.)
3. Leaks on suction side of pump. (Very common problem.)	Pressurize system and inspect.

Troubleshooting

Pump Runs But . . .

PROBLEM:

4. Jet assembly plugged.

5. Punctured diaphragm
in air control.
Galvanized tanks.

6. Original installation,
incorrect nozzle or
diffuser combination.

ANSWER:

A. Shallow Well system Clean if necessary. (Insert wire through 1/2" plug in shallow well adapter.)

b. Deep Well system Pull jet assembly and clean.

Disconnect the tubing and plug the connection in pump. If this corrects the trouble, the air control must be replaced.

Check rating in product catalog.

Troubleshooting

Pump Runs But . . .

Pump starts and stops too often . . .

POSSIBLE CAUSE:

ANSWER:

- | | |
|---|--|
| 1. Leaks in piping system. | Pressurize piping system and inspect. Repair or replace. |
| 2. Faulty pressure switch. | Check contact points. Adjust or replace switch. See I |
| 3. Waterlogged galvanized tank, faulty air control. | Pumps using Brady control: Test by holding your ear on air control. If control is operating, air can be heard passing from control into tank when pump stops. If no air movement is heard, air control should be replaced. |
| 4. Leaking tank or air valve. | Use soapy water to find leaks. Repair or replace. |

Troubleshooting

Pump Runs But . . .

POSSIBLE CAUSE:	ANSWER:
5. Not enough suction lift on shallow well system – water flows into pump (flooded suction).	Throttle suction line with partially closed valve.
6. Insufficient vacuum or vacuum does not exist for long enough time to operate air control.	Pump requires minimum 3" vacuum for 15 seconds.
7. Improper air change in captive air tank.	See J in submersible section.
8. Tank too small for pump.	Replace with proper size storage tank.

Troubleshooting

Pump Runs But . . .

Pumps water, but does not develop 40 lbs. tank pressure. . .

PROBLEM:	ANSWER:
1. Leaks in well piping or discharge pipe.	Pressurize piping system and inspect.
2. Jet or screen on foot valve partially plugged.	Clean if necessary.
3. Improper pressure control valve setting (deep well only).	See 4
4. Suction lift too high for shallow well system.	Use vacuum gauge on shallow well systems. Vacuum should not exceed 22 inches at sea level.
a. Jet set too deep for deep well system.	On deep well system check ratings tables in catalog for maximum jet depth.
5. Faulty air charger.	Disconnect the tubing and plug the hole. If this corrects the trouble, the air control must be replaced.
6. Worn impeller hub and/or guide vane bore.	Replace if necessary. Clearance should not exceed .012 on a side or .025 diametrically.
7. Overpumping the well.	Throttle a valve on the pump suction – do not exceed 22" Hg.

Troubleshooting

Pump Runs But . . .

Pump develops 40 lbs. pressure, but switch does not cut out . . .

PROBLEM:**ANSWER:**

- | | |
|--|---|
| 1. Pressure switch incorrectly set. | See I in submersible section. |
| 2. Tubing or fittings between switch and pump plugged. | Remove switch tubing and/or all fittings and clean. |
| 3. Faulty switch or corroded contact points. | Replace if necessary. |

1 How to Use Volt-Ammeter For Voltage Check



CAUTION

Power is ON during voltage checking.

1. Attach leads to volt-ammeter and select proper voltage scale for voltage to be tested.
2. Place leads in A position to test for presence of incoming voltage.
 - Voltage should be within + 10% of the design voltage specified on the motor nameplate in A, B and C test positions.
3. With disconnect switch in ON position, move leads to B position and test voltage flow through fuse(s).
4. The C position tests voltage at pressure switch terminals. The voltage should be within limits with the motor operating.

Voltage Limits		
Nameplate ▼	Measured Volts	
	Min.	Max.
115V 1Ø	105	125
208V 1Ø	188	228
230V 1Ø	210	250

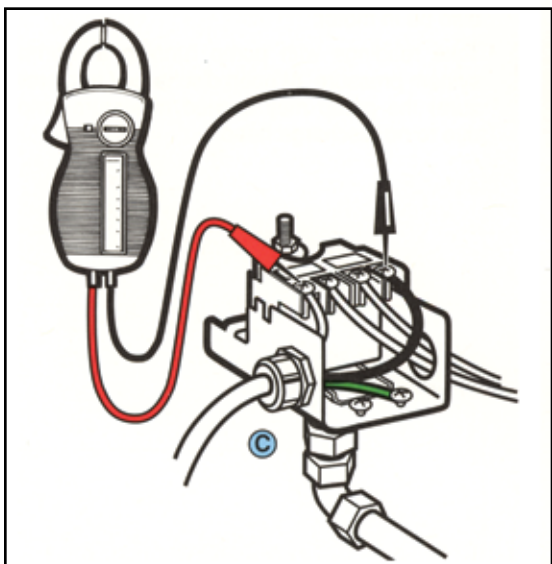
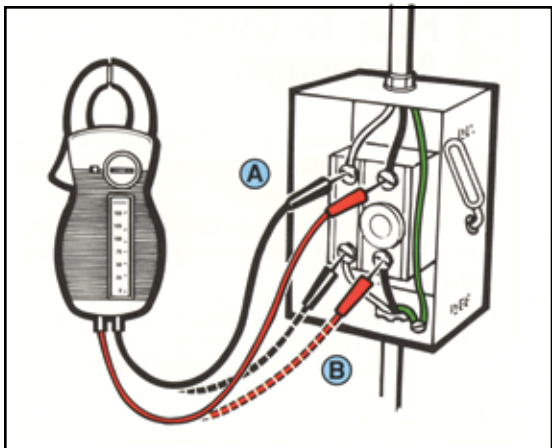

2 How to Check Amperage

1. If attached, remove leads from volt-ammeter. Select lowest reading amperage scale according to motor nameplate rating.
2. With disconnect switch in OFF position, clamp instrument around one incoming lead at pressure switch.
 - Turn switch ON and observe amperage as motor runs. With proper voltage, reading should not exceed the **MAXIMUM LOAD AMPERAGE** of motor.
 - Excessive amps means an overloaded condition or incorrect voltage applied. Problem could also be in motor.
 - Take readings with pump running at normal system pressure. At open discharge (zero pressure) the pump may exceed maximum amps due to no discharge head.

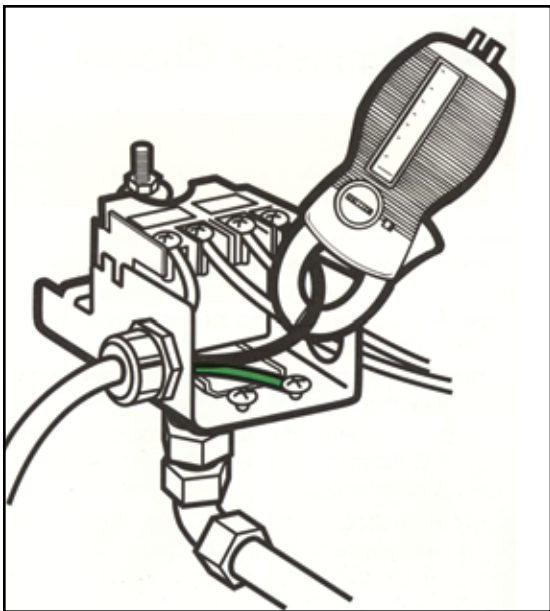

CAUTION

Power is ON during amperage testing.

2 Ohmmeter Checks . . .



CAUTION

Use ohmmeter only with **POWER OFF**.

Power supply OFF. Disconnect motor leads (L1 and L2). **On dual-voltage motors, motor must be wired 230V for the checks listed below** and illustrated on the page indicated for each check. Rewire for 230V if necessary.



CHECK:	Page
a. Ground	55
b. Winding Continuity	56-57
c. Contact Points (Switch)	58-59
d. Overload Protector	60-61
e. Capacitor	62-63

a Ground Check . . .



CAUTION

Disconnect Power Source before checking.

- a. Set ohmmeter to R x 1,000.
- b. Attach one probe to ground screw and touch other probe to all terminals on terminal board, switch, capacitor and protector – any ohmmeter reading indicates ground.

If digital meter is used, the reading should be at least one megohm.

- c. If grounded, check all external leads for cuts, breaks, frayed wires, etc. Replace damaged leads and recheck for grounds and proper lead routings. **Make sure replaced leads are not pinched between canopy and end bell.**

If ground is in stator, replacement of motor is recommended.

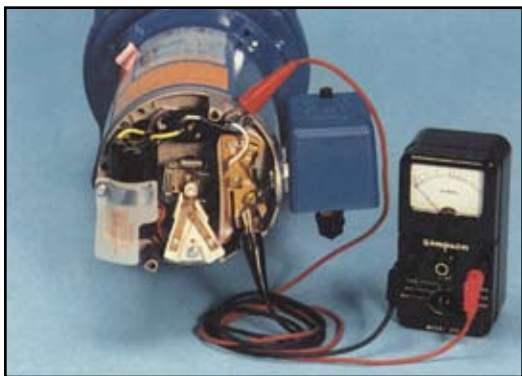

2 Ohmmeter Checks . . .

b Winding Continuity . . .



CAUTION

Disconnect Power Source before checking.

1. Terminal board connected for 230 V.
2. Set ohmmeter to R x 1, adjust to 0.
3. Slip a heavy piece of paper between motor switch points, discharge the capacitor and take the following ohm readings:
 - a. Resistance between L1 and A must be the same as between A and yellow.
 - b. Yellow to red (winding side of switch) must be the same as L1 to same red terminal.

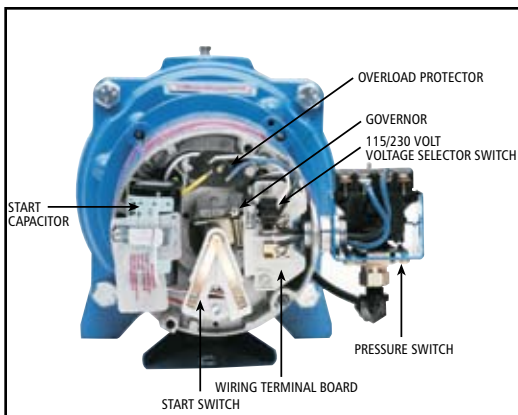

L1 = Blue wire

L2 = White wire

A = Purple wire

Ohmmeter tests on the new style terminal board with the quick-change voltage terminal plug, see picture on pg. 60 (Black plastic part with 2 wires in it) is simplified if your ohmmeter is equipped with the sharp, pointed probes rather than alligator clips. With the voltage change plug on the 230 volt terminal the Black wire in the plug is positioned on Terminal "A". Simply touch one ohmmeter probe on the Black wire in the voltage change plug to get the "A" terminal reading. Another method is to remove the terminal board screws and place the alligator clip on the wire on the bottom side of Terminal "A".

Old Style (Brown) Terminal Board Wiring.

A.O. SMITH MOTOR WIRING	
115 VOLT Black (from motor) on L1 Black/White (Black tracer from overload) on A	230 VOLT Black (from motor) on A Black/White (Black tracer from overload) on B

2 Ohmmeter Checks . . .

C Contact Points (switch) . . .



CAUTION

Disconnect Power Source before checking.

1. Set ohmmeter to R x 1, adjust to 0.
2. Remove leads from switch.
3. Attach ohmmeter leads to each side of switch – reading should be 0.
4. Flip governor weight to run position.
Reading should be infinity.

2 Ohmmeter Checks . . .

d AO Smith Motor Overload Protector . . .



CAUTION

Disconnect Power Source before checking.

1. Set ohmmeter to R x 1, adjust to 0.
2. Disconnect the overload leads.
3. Check resistance between terminals 1 and 2, then 2 and 3. If either reading is higher than 1, replace the overload.

1 = Blue wire

2 = Black/white wire

3 = Yellow wire



Motor Terminal Board and Voltage Change Plug

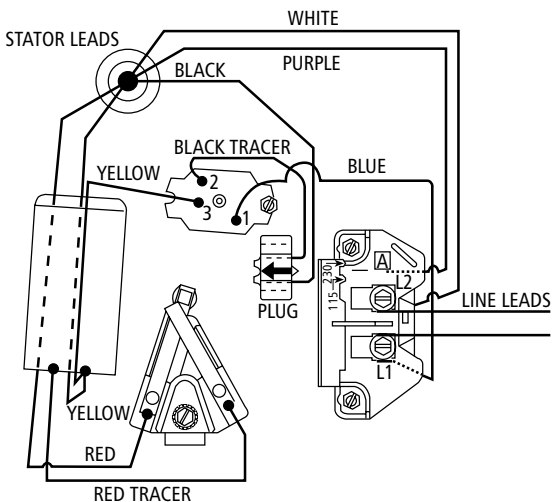

"Black Tracer" is a black and white wire

Motor Terminal Board and Voltage Change Wiring

(OLD STYLE – UP TO APRIL, 1999)

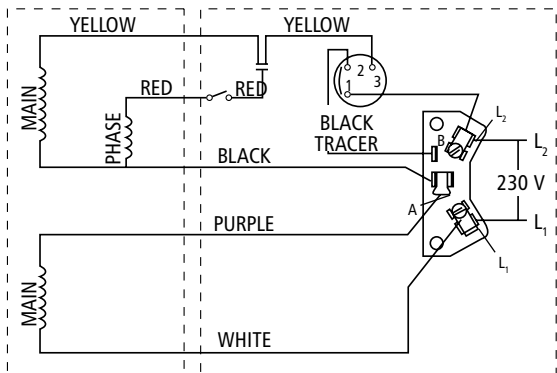

"Black Tracer" is a black and white wire

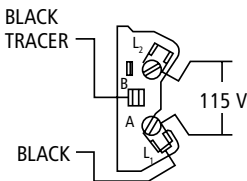

TO WIRE FOR 230 V:
BLACK TRACER TO B
BLACK TO A

TO WIRE FOR 115 V:
BLACK TRACER TO A
BLACK TO L₁

2 Ohmmeter Checks . . .

e Capacitor . . .



CAUTION

Disconnect Power Source before checking.



IMPORTANT

Discharge capacitor by touching the two terminals with the blade of an insulated handle screwdriver.



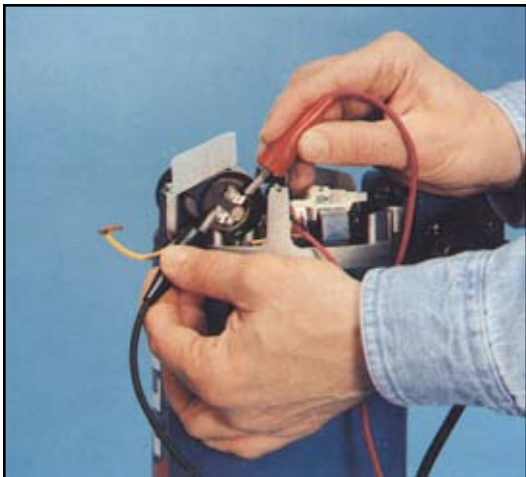

1. Set ohmmeter to $R \times 1,000$, adjust to 0.
2. Disconnect leads on capacitor.
3. Attach ohmmeter leads to each terminal. Needle should swing to right and drift slowly to left. To double check, switch ohmmeter leads and repeat procedure.
If the needle will not move or moves toward 0 and stays there, the capacitor is bad.
4. If a digital meter is used, readings should start low and rapidly increase to maximum value.

3 Checking Suction Lift . . .

A vacuum gauge indicates total suction lift (vertical lift + friction loss = total lift) in inches of mercury. 1" on the gauge = 1.13 ft. of total suction lift (based on pump located at sea level).



RULE OF THUMB

Practical suction lift at sea level is 25 ft. Deduct 1 ft. of suction lift for each 1,000 ft. of elevation above sea level.

Shallow Well System

Install vacuum gauge in shallow well adapter. See opposite page. When pump is running, the gauge will show no vacuum if the end of suction pipe is not submerged or there is a suction leak. If the gauge shows a very high vacuum (22 inches or more), this indicates that the end of suction pipe is buried in mud, the foot valve or check valve is stuck closed or the suction lift exceeds capability of pump.



High Vacuum (22 inches or more)

- Suction pipe end buried in mud
- Foot valve or check valve stuck closed
- Suction lift exceeds capability of the pump



Low Vacuum (or 0 vacuum)

- Suction pipe not submerged
- Suction leak



Compound Vacuum Pressure Gauge

This gauge will show the pressure or vacuum at any position in a pump or system where it is installed.

A reading of 20" on a vacuum gauge placed on the suction side of the pump would tell you that you have a vacuum or suction lift of 22.6 ft.

$$20'' \times 1.13' = 22.6 \text{ ft.}$$

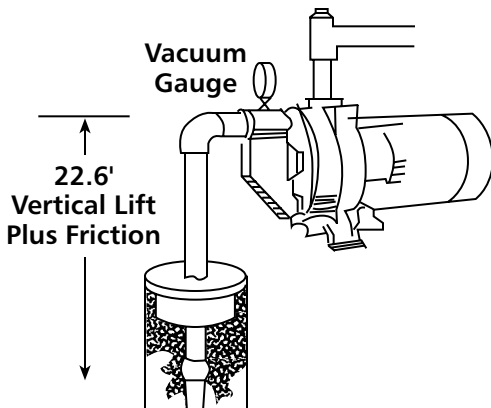

4 Pressure Control Valves . . .

When pump is first started or under maximum flow condition, pressure control should be immediately adjusted to the pressure corresponding to H.P. and jet assembly used. See rating tables in catalog for proper pressure setting.

1. Turn left to reduce pressure.
2. Turn right to increase pressure.



RULE OF THUMB

If pressure control valve is set too high, the air volume control will not function.

If pressure control valve is set too low, the pump may not shut off.

To Adjust Pressure Control Valve:

1. Close pressure control valve.
2. Open faucet in house.
3. Turn pump on.
4. As pump picks up its prime, the pressure will begin to rise on the gauge.
5. Turn adjusting screw to set pressure control valve to pressure recommended in catalog.

AV15



Use with $\frac{1}{2}$ and $\frac{3}{4}$ HP pumps requiring control valve settings up to 35 PSI.

AV22



Use with pumps requiring 35 PSI or higher control valve setting: Typically all multi-stage units and single-stage pumps 1 HP and larger.

AV1
AV21

Use with deep well multi-stage and high pressure units.

Jet Pump Disassembly . . .

1. Turn off power to motor. Disconnect service wires from pressure switch.
2. Drain system to relieve pressure.
3. Disconnect motor cord from pressure switch when used.
4. Remove casing bolts. If pump is mounted on top of tank, remove bolt holding motor adapter to mounting pad.
5. Disconnect tubing between casing or pressure control valve and pressure switch.
6. Remove motor, motor adapter casing, and rotating element. Casing remains attached to piping.
7. Remove guide vane seal ring and diaphragm gasket ring.
8. Remove guide vane from motor adapter (via 4 bolts or may be snap in type).
9. A.O. Smith Motors – Remove motor end cover. Insert $\frac{7}{16}$ " open end wrench under switch mechanism or behind overload protector onto flats on motor shaft.
While holding the shaft against rotating, turn the impeller counterclockwise. The impeller should turn completely off the shaft in this manner.
10. Using two screwdrivers, pry out holding collar of mechanical seal assembly.
11. Motor adapter can be unbolted from the motor (for motor replacement).



Jet Pump Reassembly . . .

1. Be sure that recess for seal seat and surface where guide vane mounts on motor adapter are entirely free of all scale and dirt.
2. Clean motor shaft.
3. Apply film of light oil, such as vegetable oil, to the recess of the motor adapter and the neoprene bushing before installing the new seal seat. This is a tight fit, but it must go in all the way evenly, or a leak will result. Do not mar lapped face of this seal. The slightest scar or particle of dirt will cause a leak.
4. Bolt motor adapter to motor, making sure the motor shaft does not dislocate the stationary seal member.
5. Assemble rotating member of seal on motor shaft. Rotating seal face must fit snugly against lapped seal face of stationary member in casing cover. This is accomplished by pushing with a piece of tube against back end of neoprene washer after oiling sleeve and shaft. Be sure rotating seal face does not drop out of holding collar while sliding the rotating members of the seal on the shaft. Also, take extra care that the rotating seal face is not marred during handling.
6. While holding the shaft against rotating, screw impeller on shaft by hand until tight against shoulder of motor shaft.
7. Replace guide vane, making sure that bore of guide vane does not bind impeller hub. If screws used, tighten alternately and evenly. Check by turning the motor shaft. If binding occurs, loosen screws, readjust guide vane until impeller hub turns freely, then tighten screws as before. Some jets have snap-in guide vane.

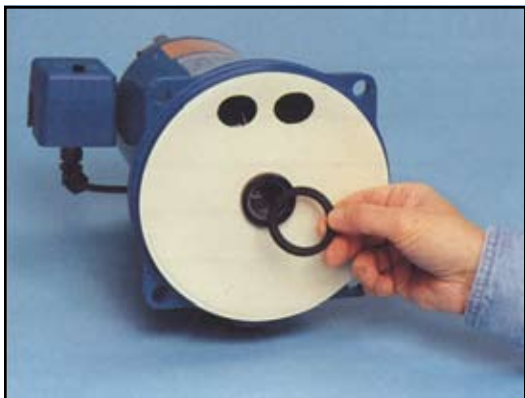

8. Replace diaphragm gasket with opening in the upper position.
9. Replace guide vane seal ring on guide vane hub.
10. Make sure all gasket surfaces are clean.
Replace pump casing.
11. Tighten casing bolts alternately and evenly.
12. After reassembling pump, check to be sure impeller rotates freely.
13. Reconnect tube between pressure switch and casing cover or control valve.
14. Close all drain openings, using pipe joint compound or teflon tape on threads of plugs.
15. Prime according to Priming Instructions.



RULE OF THUMB

Do not start motor until pump and suction piping are filled with water.



ITT

Residential Water Systems

 **GOULDS PUMPS**

Goulds Pumps, CentriPro and the ITT Engineered Blocks Symbol are registered trademarks and tradenames of ITT Corporation.

SPECIFICATIONS ARE SUBJECT TO CHANGE WITHOUT NOTICE.

GSSINGLE May, 2008

© 2008 ITT Corporation

Engineered for life